

Alpine Living for SAR

- Think Survival vs. Comfort.
- Remember, for SAR missions you might be forced to stay out over 1 night (24 hours).
- This is not a long backpacking trip.
- Insulate yourself from the cold.
- You need to be able to purify water and stay hydrated.
- Shelters protect you from the elements.
- You need a minimal shelter that helps trap heat.
- Think about a sleep system instead of just a sleeping bag to keep you warm enough overnight.
- Think about food appropriate for SAR missions.
- Food is fuel, and food is heat.
- Can you build a fire in the snow?

Insulate yourself from contact with cold.



Your foam pad is useful anytime you need to sit down in snow or on cold ground. It prevents heat-loss due to conduction.

Traditional Water Purification

METHOD	EFFECTIVENESS	ADVANTAGES	DISADVANTAGES
Boiling	Very effective against all pathogens.	Most effective method.	Very slow and inconvenient. Requires fuel, which may be too heavy for long trips.
Iodine	Very effective against bacteria and viruses. Effective against <i>Giardia</i> , but requires soak time. Not effective against <i>Cryptosporidium</i> .	Can be combined with filtering to protect against all pathogens.	Not to be used as the sole method of purification. Slow; extra slow for cold water; disagreeable taste.
Filtering	Very effective against large parasites. Effectiveness varies against bacteria, depending on filter. Not effective against viruses.	Relatively quick.	Expensive; may be bulky or heavy; may clog or break.

Newer Water Purification

METHOD	EFFECTIVENESS	ADVANTAGES	DISADVANTAGES
Miox	Very effective against bacteria, viruses, bacteria, Giardia, and Crypto.	small, light, pleasant taste	requires batteries might have issues in cold requires salt crystals takes practice
Katadyn Micropur Tablets	Very effective against against bacteria, viruses, Crypto, and Giardia.	small, light, pleasant taste	?

Both of these products require the following times to purify at moderate and above temperature. The will increase in colder weather.

5 min for Viruses & Bacteria

30 min for Crypto & Giardia

4 h, worst case Crypto

Boiling Considerations

Elevation		Temperature		Cooking Time (sea level = 1)
ft	m	°C	°F	
sea level		100°	212°	1.0
5,000	1,525	95°	203°	1.9
10,000	3,050	90°	194°	3.8
15,000	4,575	85°	185°	7.2
20,000	7,000	80°	176°	13.0

Stoves

Considerations:

- ease of use
- easy to light?
- type of fuel?
- efficiency in cold?
- efficiency at altitude?
- weight
- For SAR, a stove that is for boiling water is more than adequate. No need to do baking on our missions.

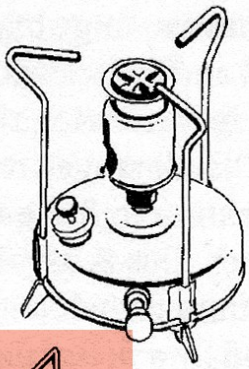

← **Kerosene stove:** high heat output; requires white gas, alcohol, or lighter fluid for priming.

White gas stove with enclosure: compact carrier for safe, convenient packing.

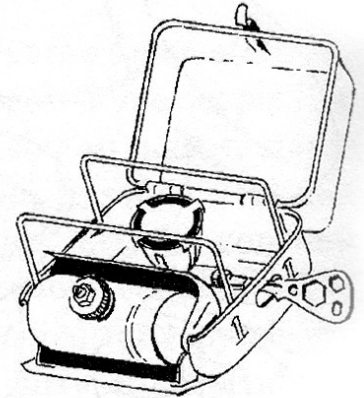

← **Butane/propane cartridge stove:** uses 80 percent butane/20 percent propane for better cold-weather performance.

White gas stove: white gas only; burns hotter and boils water more quickly than other fuels.

← **White gas/kerosene stove:** burns either fuel; ideal stove for international use.

Multi-fuel stove: burns most fuels—white gas, leaded or unleaded automobile gas, aviation gas, deodorized or regular kerosene, Stoddard Solvent No. 1, diesel fuel or No. 1 stove oil; easy to clean; ideal when clean fuel not available.

← **Isobutane stove:** uses isobutane for best performance in cold weather.

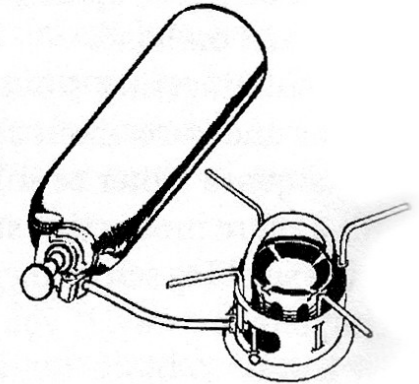
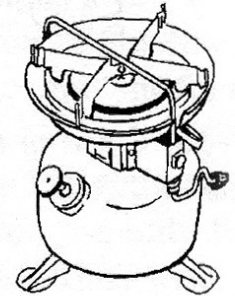
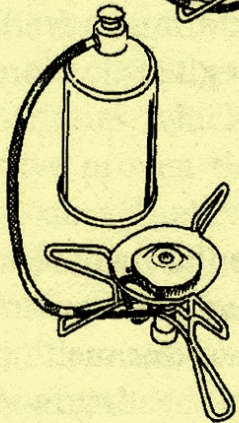
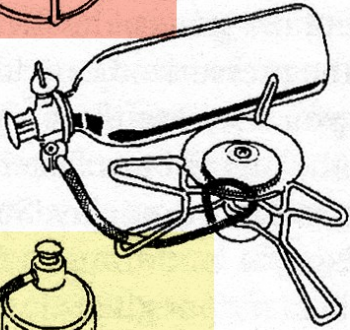
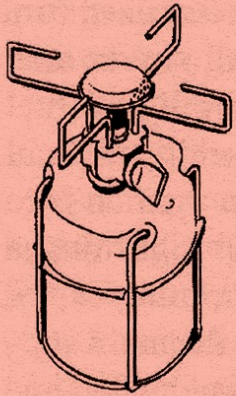

Stoves

Most SAR members have found that a simple stove such as the Jetboil, MSR Pocket Rocket, and the new MSR Reactor Stove are good for SAR missions.

These stoves run on ISO butane and ISO propane cartridges (depending on the specific stove).

Such fuel cartridges need to be kept out of the cold as much as possible in order to run efficiently. Cold temps make the mixture begin to separate. After dark or in cold weather, put the cartridge in your jacket close to your base-layer of clothing until you need to use it.

Also consider a piece of foam to go under the fuel cartridge to protect it from the snow.

Why be concerned about a Shelter?

- Protect yourself from the elements!
- You may need to to protect the patient from the elements!
- Humans have a narrow range of survival while in cold, windy, and wet environments.

Bad Shelters

- Automobile - metal box is a refrigerator!
- Vulnerable locations - discussed later

Shelters

Shelter: Protects you from the environment

Examples:

- Your clothing!
 - In an emergency your shell clothing is a bivy sack!
- Tent
- Bivy Sack
- Tarp
- Trench with Cover (tarp cover)
- Snow Cave or Mound Shelter (not recommended for SAR)
- Igloo (not recommended for SAR)

General Shelter Considerations

Thermal Efficiency

- Make sure the shelter is just large enough for the person(s) inside it.
- Your body has to warm the excess air.
- Prevent heat loss by wind chill.
- Small equals efficient.

It is best to make the entrance lower than the sleeping area. Warm air rises.

General Shelter Considerations

Ventilation

- Make sure you are not completely enclosed.
- Carbon Dioxide needs to escape.
- Avoid using stoves inside the shelter if possible.
- For snow caves, igloos, and mound shelters, remember to make ventilation holes in the ceiling.
- For tarps, the entrance is sufficient for ventilation.

General Shelter Considerations

Wind

- A shelter should be able to shed wind.
- It should be strong enough not to collapse from the wind.
- The entrance should be down wind.

General Shelter Considerations

Location

- On the side of a mountain ?
- Avoid Valley Floors (avalanche danger)
- Avoid exposed ridges due to Wind
- Wind moves down canyon at night, and up canyon during the day
- Access to a latrine
- Not in an avalanche path
- Not under a widow maker (broken tree limb)
- Access to drinking water or clean snow
- If it rains, will water drain around your shelter or through it?

General Shelter Considerations

Floor Coverings

- Your foam pad is the standard.
- BMC recommends closed cell foam pads like a Ridge Rest or Z-Rest.
 - BMC does not recommend inflatable foam pads such as a Thermarest because they can be compromised by puncture or tear.
(I know, I slept on a leaky Thermarest in cold conditions for 9 nights on snow and ice.....my body went into survival mode.)
- Your backpack has insulating foam as well.
- Materials such as rope and webbing can be used to insulate you from the snow.
- Natural materials such as foliage also be used as insulation.

General Shelter Considerations

Other

- Keep your shovel inside the shelter. During a snow storm, you may need to dig yourself out!
- Clip all gear together that is located outside of the shelter. This includes snow shoes, crampons, axe, helmet, whatever...this way, if everything gets buried in snow, it will be easy to find in the morning.
- If on a slope or near any potential fall zone, don't use your axe and crampons as anchors for your tarp. You may need these if you get up during the night and have to go to the latrine.

Shelter Comparisons

Shelter	Tent - Winter mountaineering	Snow Cave	Tarp	Snow Trench / tarp
Weight	Usually 8 lbs or more	Nothing in your pack	Some tarps weigh as little as .5 lb	Same as tarp.
Bulk	Very Bulk Can take up half a pack	Nothing	Can be as small as a pair of socks	Same as tarp.
Advantage	Good for long term use (base-camp)	Strongest of these options	Most versatile	Lightweight, warm, versatile
Dis-advantage	Who wants to carry that bulk and weight? Did you remember the poles?	Time, energy, and sweat consuming!	Needs to be anchored well during windy storms.	Keep covered to be thermally efficient

Shelter Comparisons

Shelter Type	Snow Tent	Igloo	Mound Shelter	Snow Cave	Covered Snow Trench
Time Required	A few minutes	2-3 hours (min)	3-4 hours of work 1-2 waiting for snow to settle	1-2 hours	15 min - 1 hour depending on snow depth
Energy	Minimal needed	Intensive long output	Intensive long output	Intensive long output	Minimal to Moderate
Inside Temp	Cold compared to others	Warm if done right	As warm as an igloo	Can be as warm as igloo	Less than igloo, better than tent
Skills Required	Pitching a tent	Takes practice, snow saw	Evaluate thickness of walls	Evaluate thickness of walls	Pitching a tarp, minimal
Special Considerations	None	Deep snow with good consistency	Must compact snow.	Deep Snow	2.5 feet or more of snow.

Snow Mound Shelter - Quin-zhee for 4 people

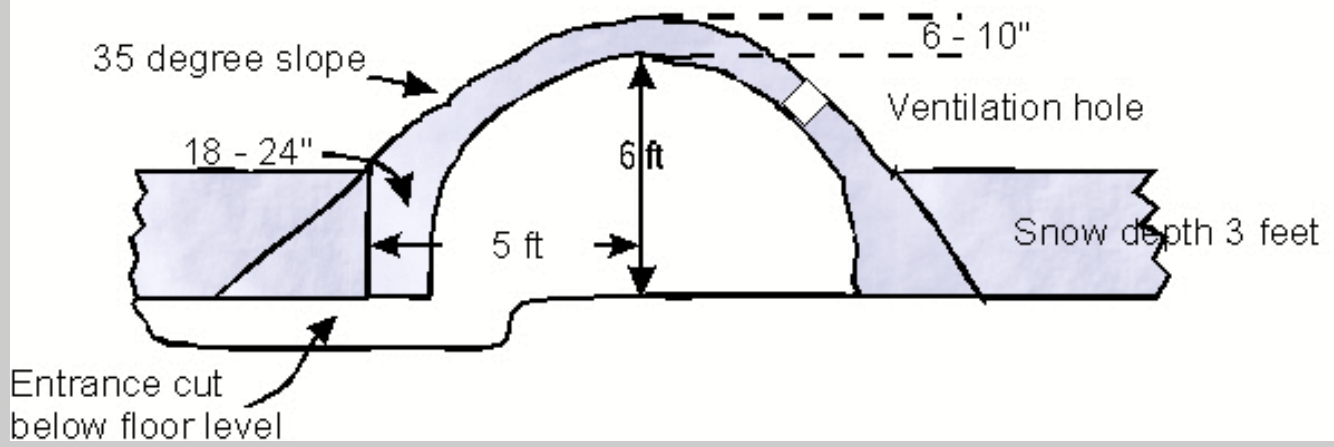

Mound Shelter for 1 person.



Snow Mound Shelter



Snow cave digging under tree branches



Snow cave on a slope

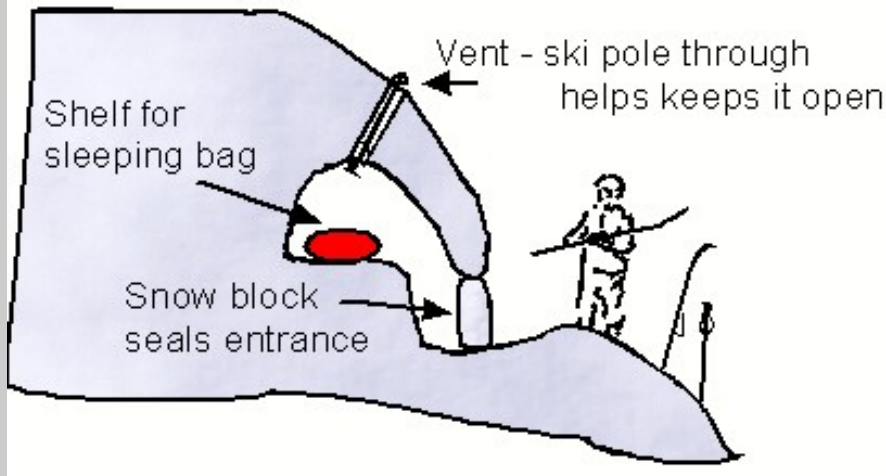

Simple Snow Caves

Complex Snow Cave

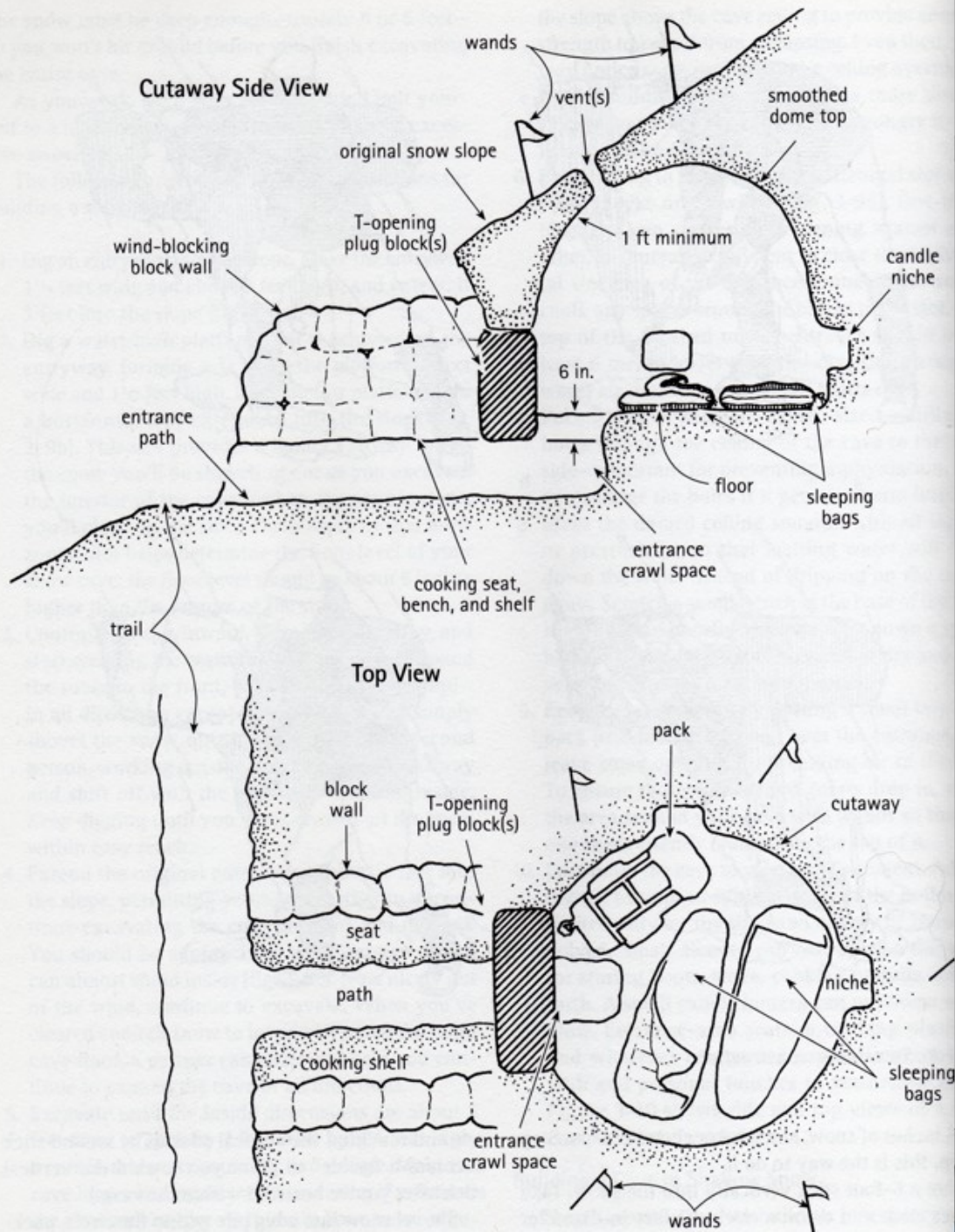

Tree Pit Cave



Tarp Shelter Considerations

- Material and Weight

Sil Nylon is the popular lightweight material

- Size (1 person or 2)
- Design - Rectangle, Shaped, or “tent” like
- Pitch Versatility

Does the tarp work in a variety of configurations?

- Do you need additional items to pitch and anchor the tarp?

A-frame style



Lean-to



Poncho Tarp - Diamond Shape



Inside a Diamond Shape Tarp



Not bad, but it would be warmer with a snow trench. Snow creates insulation and traps the body heat better than a tarp alone.

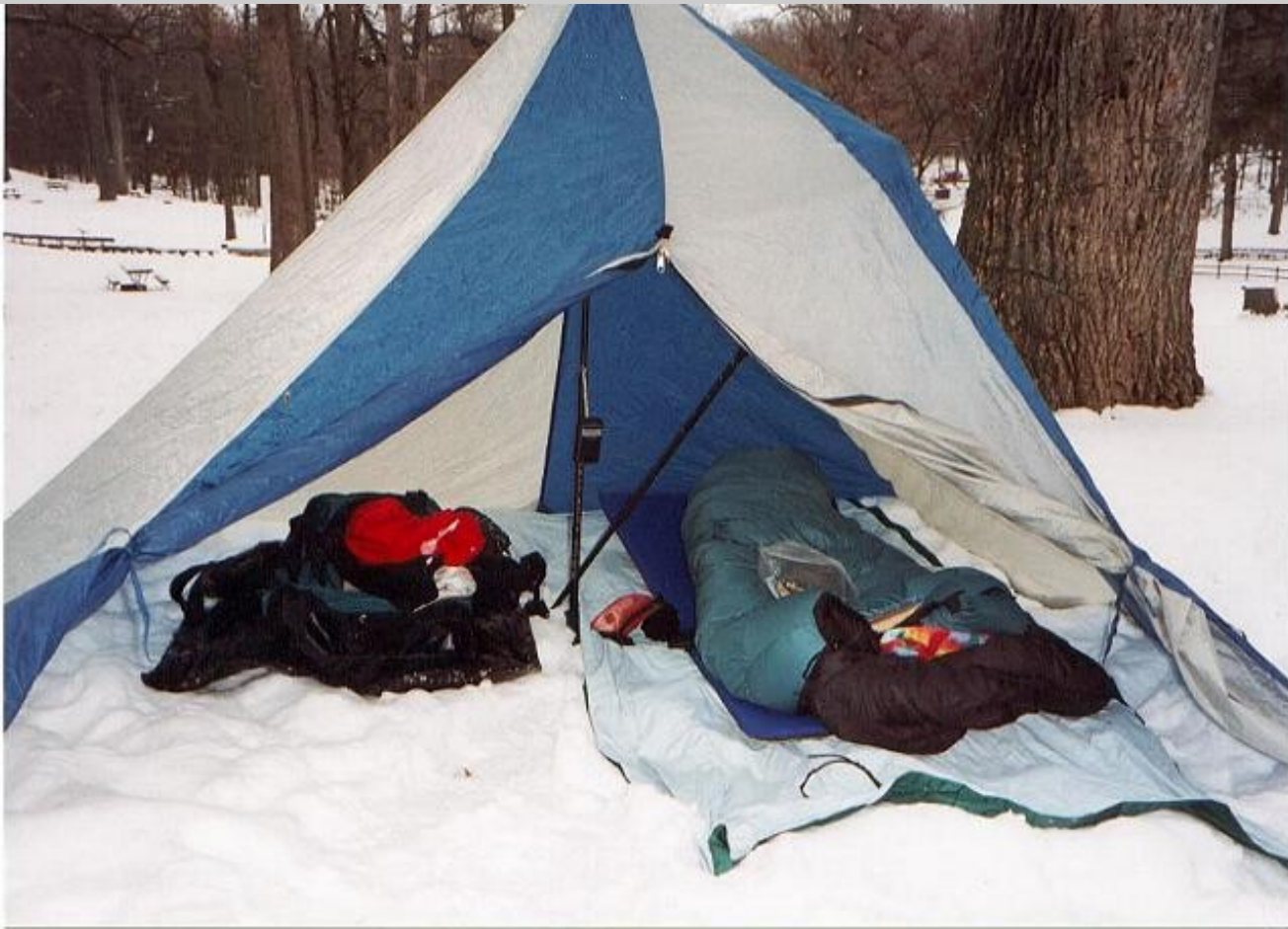

Trench with Cover

- You can cover a trench easily with a tarp if sized correctly.
- You can customize the size of the trench.
- A low profile can stand strong winds well
- The snow will help insulate.
- A small trench with tarp is very thermally efficient.

Snow Trench Shelter

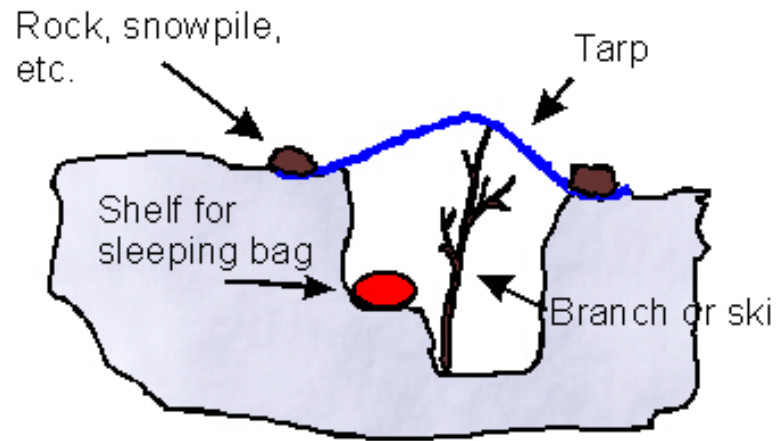

Snow Mound Trench Shelter

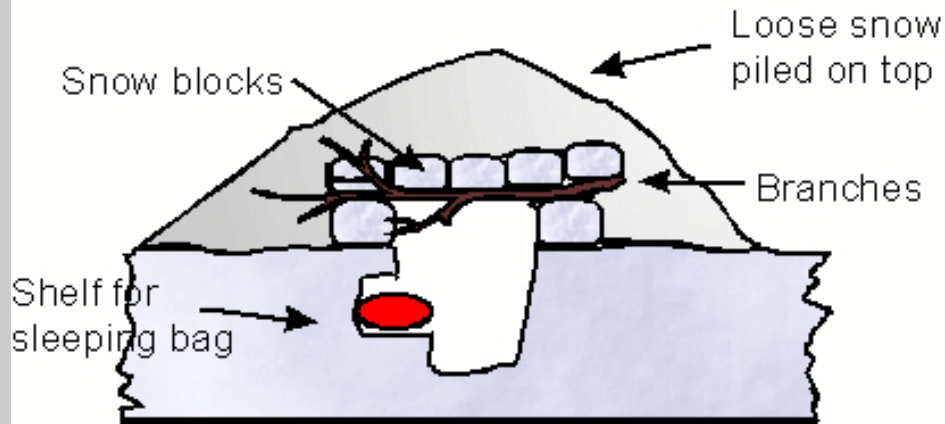

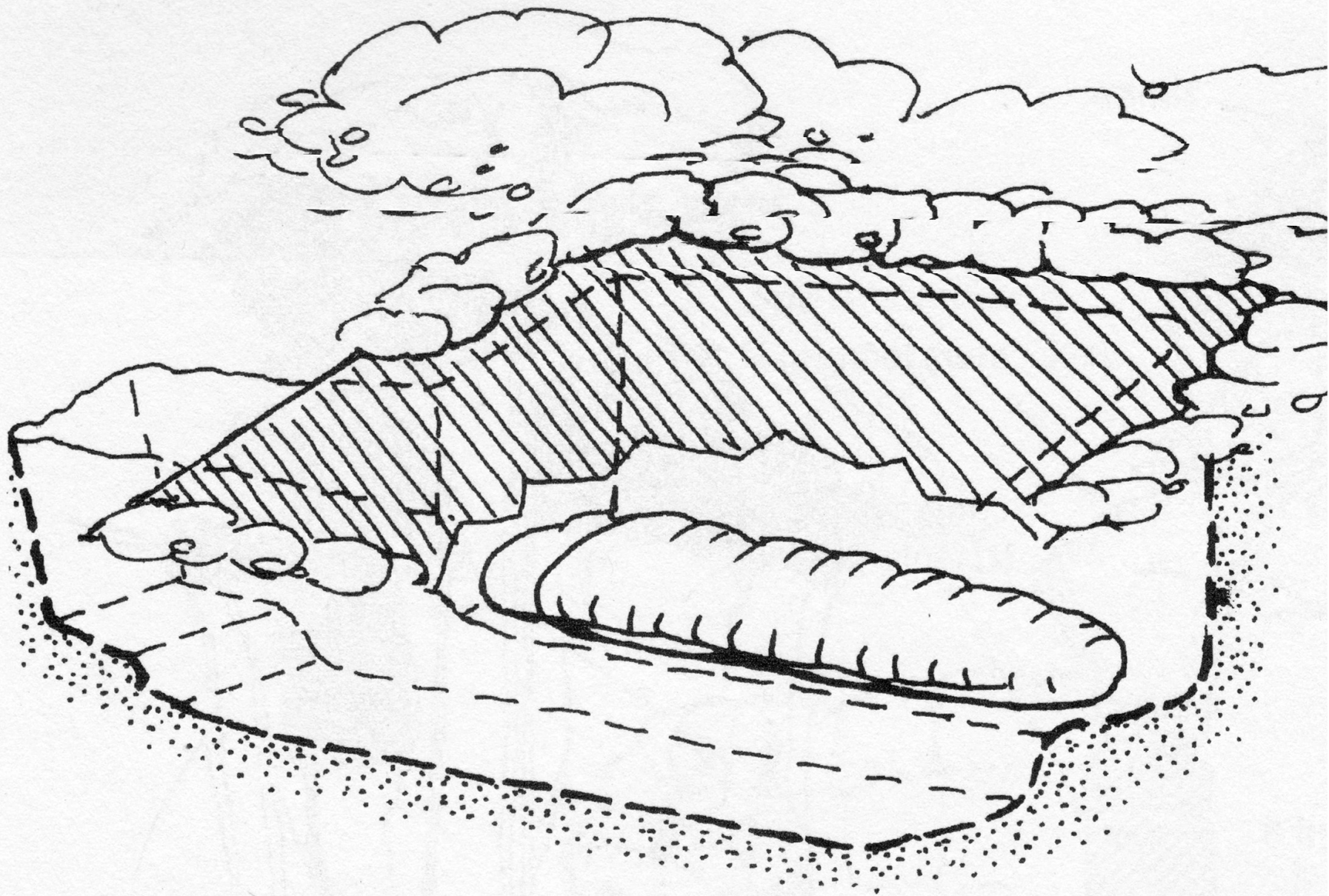

Snow Trench Shelter

Top view

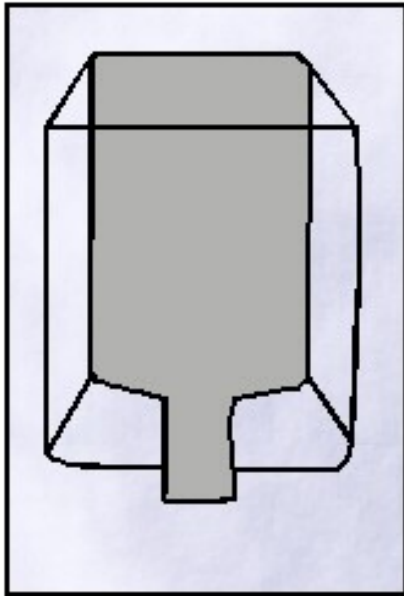

Dig a trench in the snow. Beveling the walls as you go down makes a bigger sleeping area with a smaller roof opening to cover.

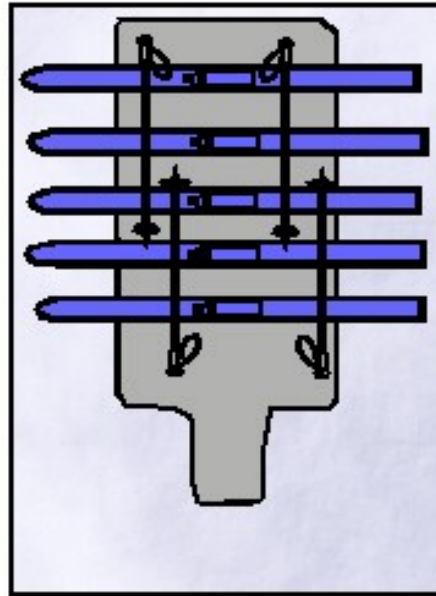

Skis and poles are laid across the trench.

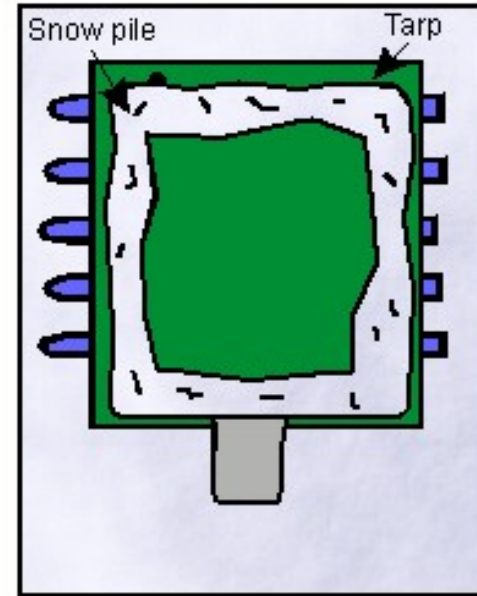

Tarp placed over skis. Snow Piled around perimeter.

End view

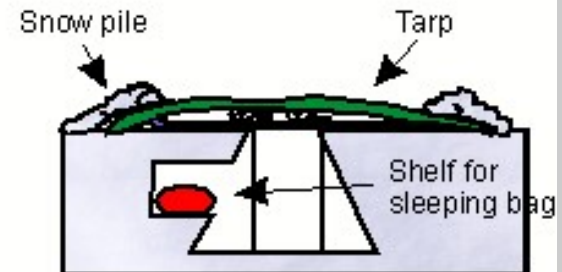
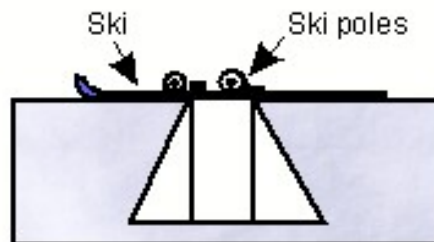
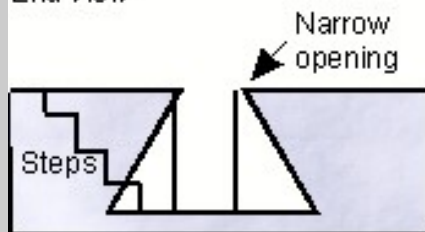

Snow Shelter Pictures from Princeton University OA Winter Activities Webpage

Snow Trench Shelter

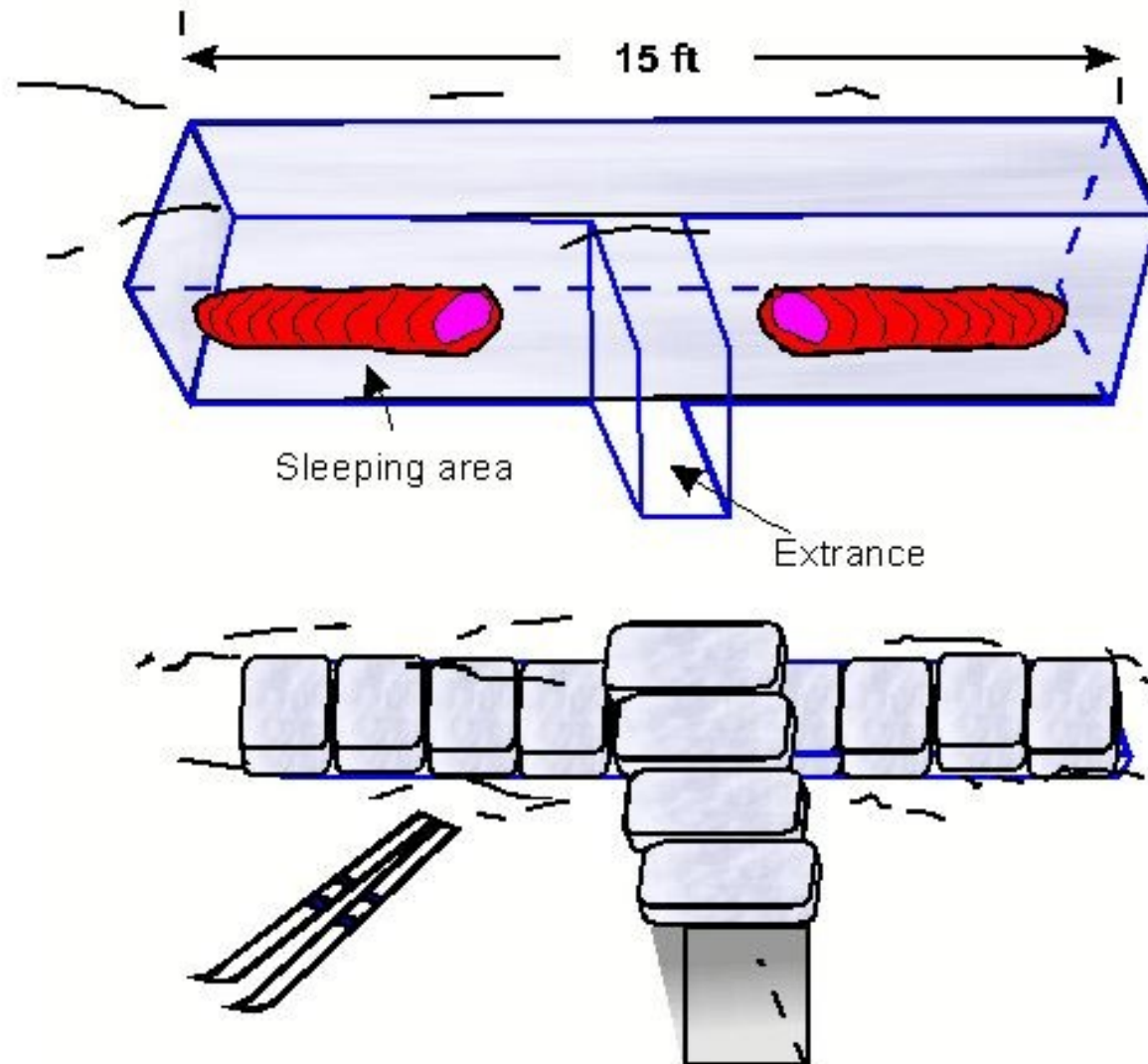

Dig blocks out of the snow to create a T-shaped trench.
Shape the blocks to create the roof.

Trench in snow with tarp cover



Trench covered with tree limbs, tarp, and snow.





Trench
without cover



This can be as little as 2.5 feet deep. Just make sure you have enough room to crawl in and out of the trench without touching your tarp.





Support the tarp. Make sure it can take snow loading throughout the night. It is recommended that you use one of your trekking poles inside the tarp to create more of a pyramid shape.

Otherwise, use horizontal braces under the tarp made from sticks, or trekking poles.



This may work as a support for the tarp. It is recommend that the pole be in the center of two people. With a two person shelter, you have a more efficient design, and an extra body to generate heat.

Other Tarp Roof Supports

- Accessory Cord
- Sticks
- Trekking Poles laid flat across trench.

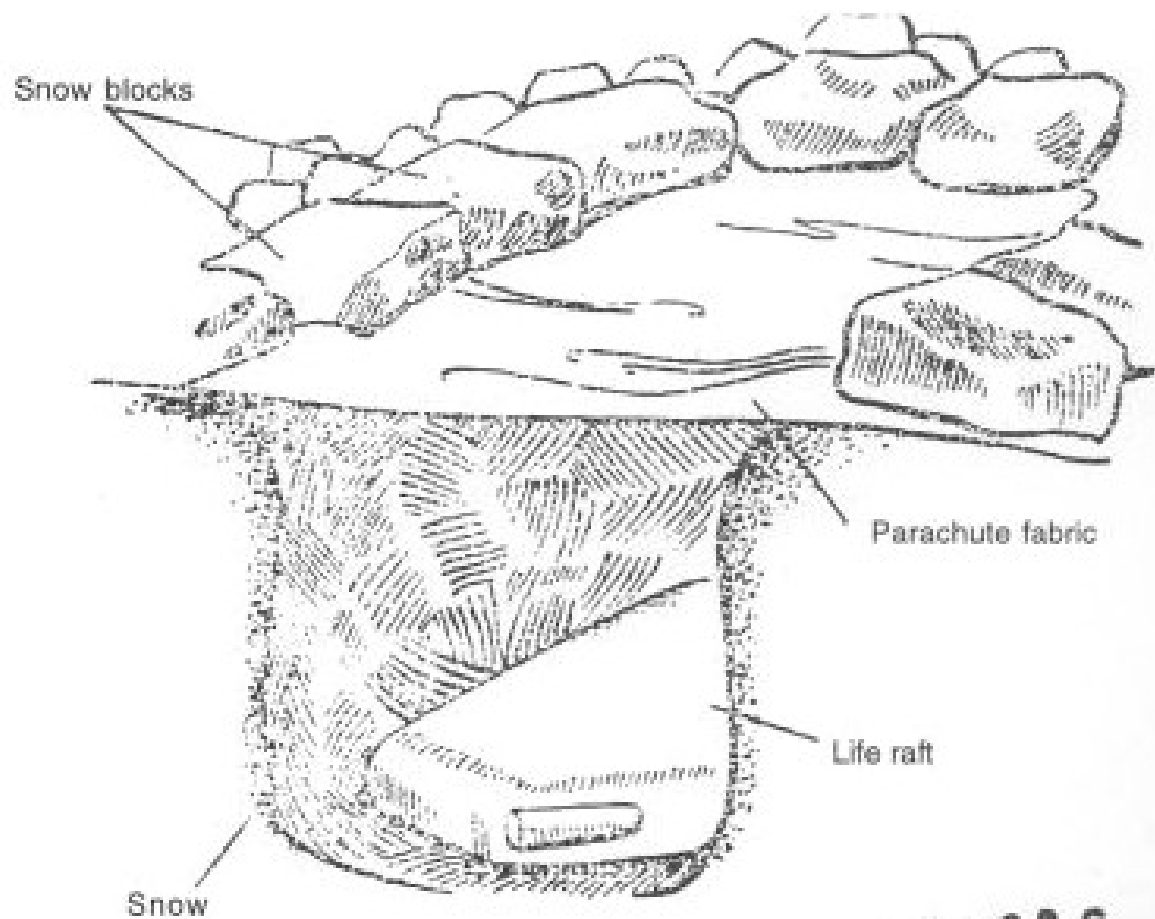

10-5886

Picture 11. CONSTRUCTION OF A SNOW TRENCH





This person used a fallen tree as one wall of the shelter. It is sort of a lean-to tarp with snow trench.

You can use a jacket, a pack, or anything you have to block the entrance. This will keep the shelter warmer.

I recommend taking your pack inside and using the foam as extra insulation under you while sleeping.

Anchoring Material for Tarps

- Use what you have!
- Tie outs:
 - Items like snow shoes work great to tie to.
 - Natural anchors such as tree or shrubs.
 - Rocks
- Have guy-out lines on your tarp.
- Have extra cord just in case.
- Natural anchors such as trees.
- Deadman anchors
 - stuff sacks filled with snow
 - sticks you find
 - wads of string

Useful Knots for Tarp Guy-lines

- Bowline (attach cord to tarp)
- Taut-line hitch (adjustable knot, good for tensioning)
- Trucker's hitch (adjustable knot, good for tensioning)
- Powercinch (adjustable knot, good for tensioning)
- Siberian hitch (quick release knot around an anchor)
- Clove hitch (wrap around an object like a stick)

Taut-line Hitch

- Good for tensioning
- Adjustable

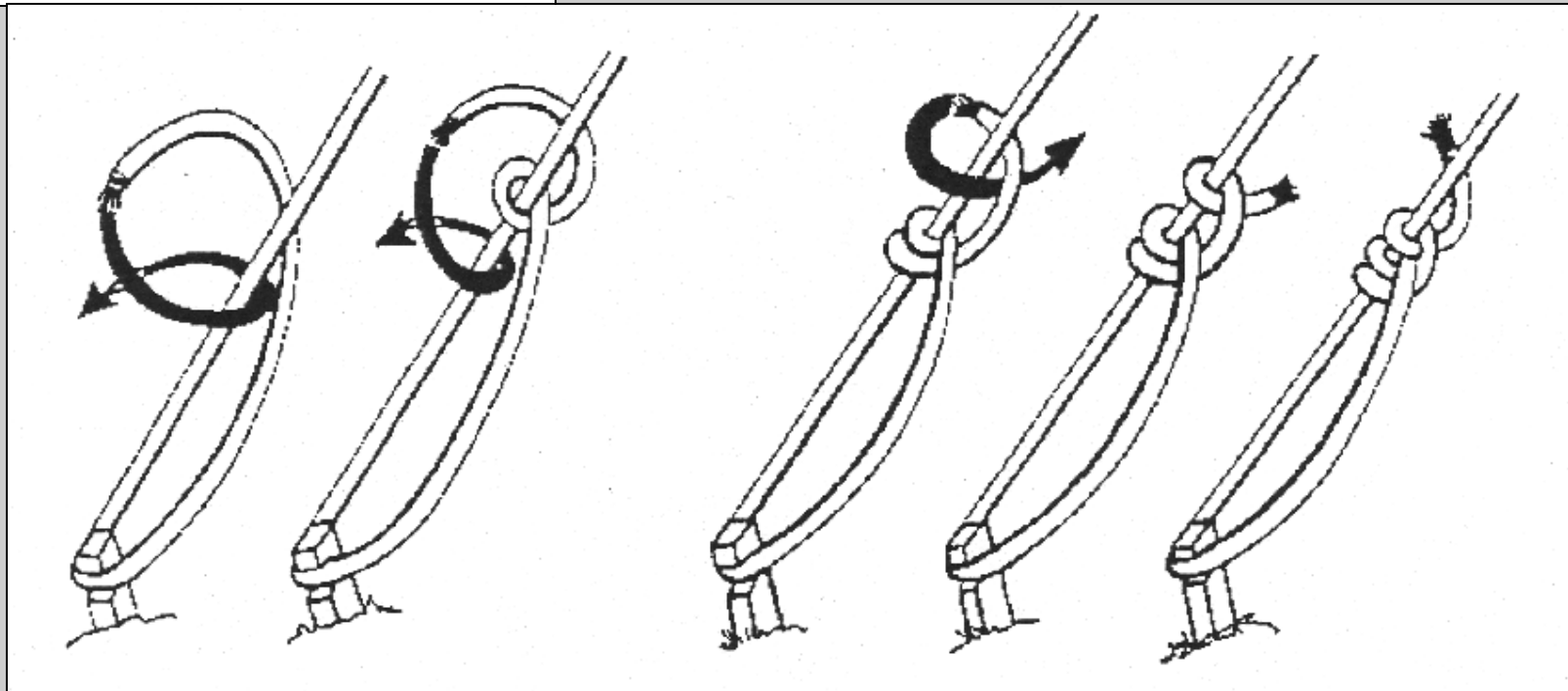
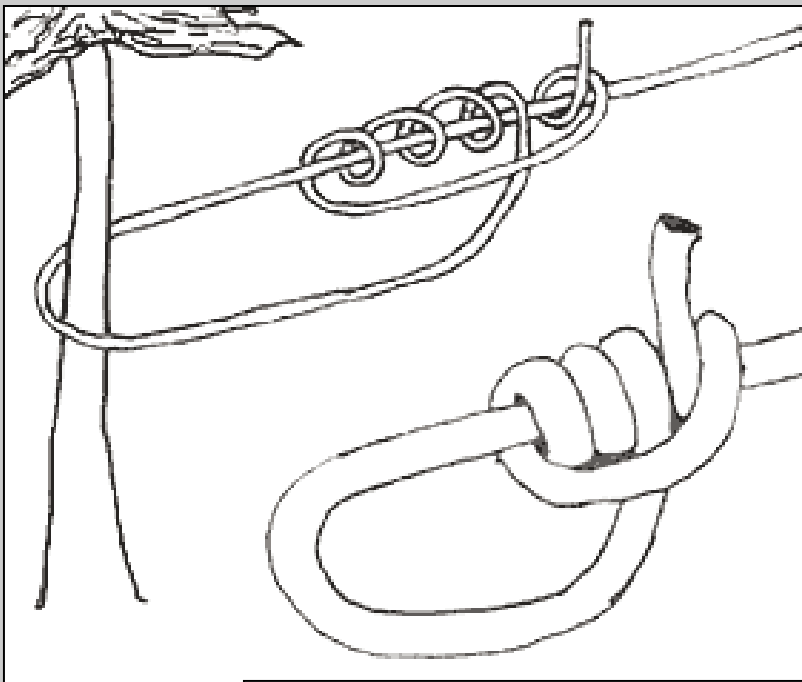

Tensioning Hitch

- Good for tensioning
- Adjustable

Tensioning Hitch

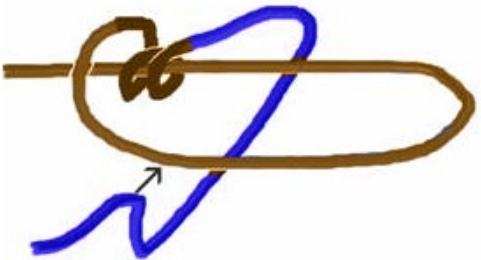
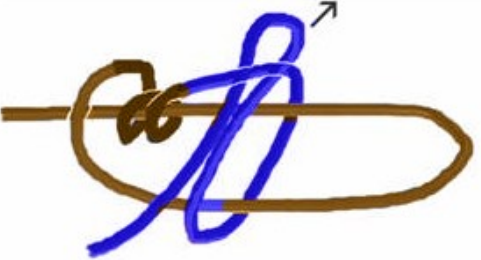
		
<p>Make a loop and coil the working end around the standing part twice. Be sure to make the coils on the <i>inside</i> of the loop as shown.</p>	<p>Now pass the working end halfway around the entire loop (in front of the coils). Next, form a bight which will continue around the loop and tuck under the working part as shown in the next frame.</p>	<p>Tighten by first pulling bight in direction of arrow, then by pulling back towards the standing end. To release, pull on the working end.</p>

Powercinch

- Can wrap around an anchor
- Adjustable

Powercinch

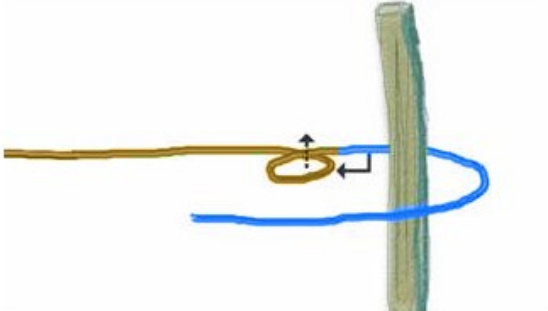
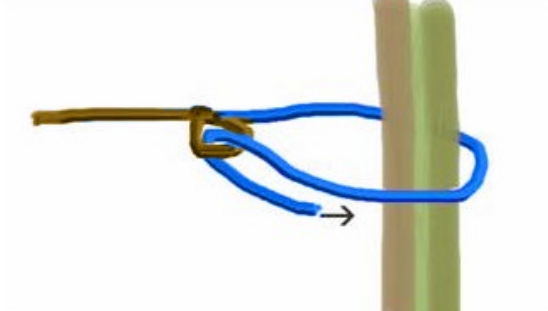
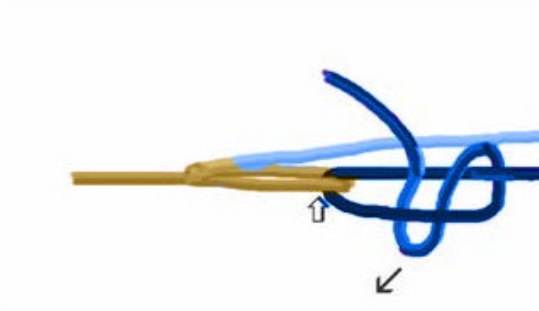
 A diagram showing a rope with a standing part on the left and a working end on the right. The working end is being used to form a loop in the standing part. A white arrow points up, and a black arrow points left, indicating the direction of movement.	 A diagram showing the working end of the rope being passed through the loop formed in the previous step. A black arrow points right, indicating the direction of movement.	 A diagram showing the ropes being pinched together at a point. A white arrow points up, and a black arrow points down, indicating the direction of movement for the ropes.
<p>Form a loop in the standing part of the rope. Reach through the loop and pull a bight <i>in front of the loop</i> through.</p>	<p>Pass the working end through the knotted loop formed by the previous step and pull backwards to tighten ridgeline.</p>	<p>With one hand, pinch the ropes at the white arrow to hold tension. With your other hand, tie a slippery half hitch as shown above to secure knot. Tug on working end to release knot.</p>

Trucker Hitch

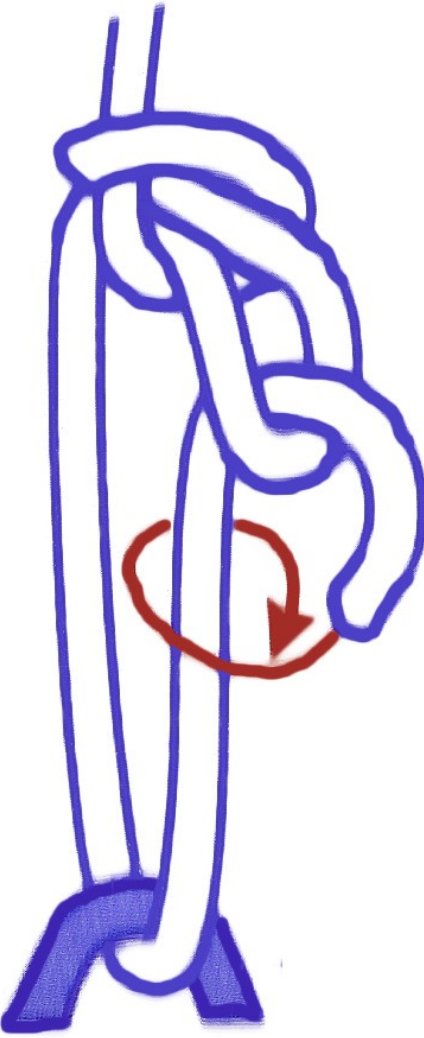
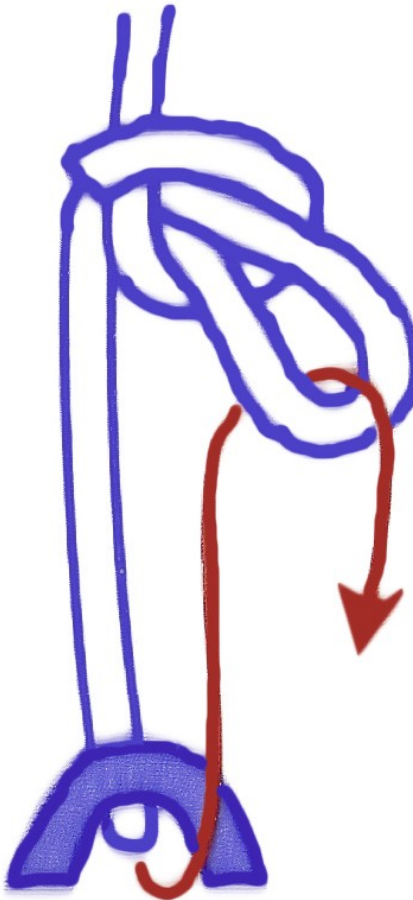

Siberian Hitch



Clove Hitch



Tips For Sleeping Warm

- Eat and drink well before you go to bed - calories are heat.
- Keep shelter small. The less air you have to warm up, the more your shelter insulates you.
- Use a pee bottle. Try not to get up leave your shelter at night.
- Make sure you have on dry socks.
- Wear a hat.
- Warm water bottle trick.

Sleep Systems

- Tarp or Shelter on top
- Bivy Sack
- Inside Bivy Sack, you have sleeping bag and a puffy jacket for blanket.
- Wear the rest of your clothes
- Insulating ground pad underneath
 - You can use a 3/4 pad for your upper body, and the foam in your backpack for your lower body.

Optional - Vapor Barrier in Sleeping Bag

Fire Building

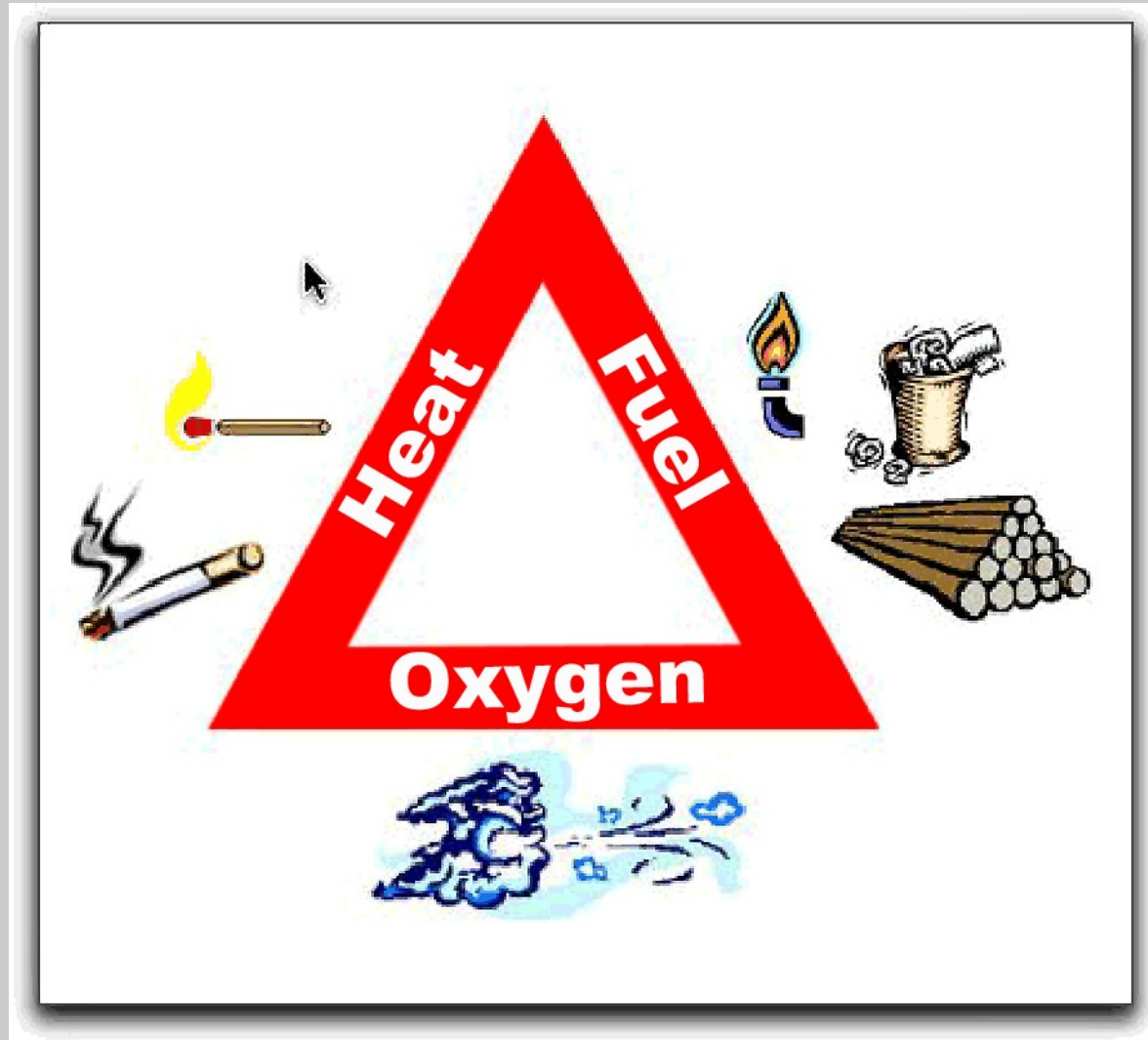

Fire Building

- Why build a fire
- General considerations
- Safety
- Materials
- Design layout

Why Build a Fire?

- Warmth
- Light
- Signal
- Cooking / Boiling
- Psychological Comfort
- Is it necessary for SAR?
- Is it necessary for Survival?

Building A Fire

- Prepare ground with mineral soil or platform on snow.
- Set up fire circle.
- Use a reflective back drop if possible.
- Gather everything needed before igniting fire.
- Arrange so breeze can fan fire.
- Arrange so wind does not put out fire.
- Pick Design.
- Start with tender or fuel tablet.
- Progress to Kindling.
- Arrange so flames lick larger pieces of wood progressively.
- Don't smother fire. Let it breathe

TINDER

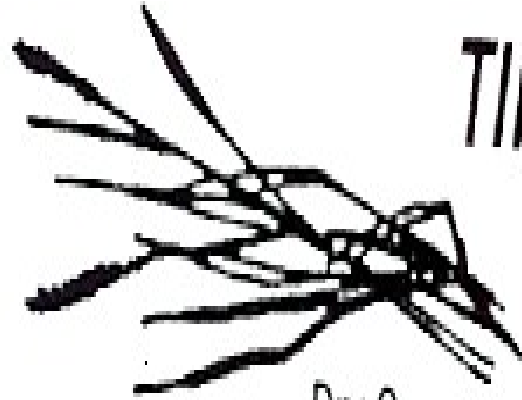

Dry Grass

Pitch
Wood

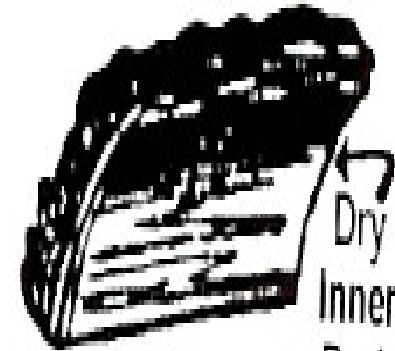

Dry
Inner
Bark



Fuzz or Lint



Cotton Balls

Seed Down

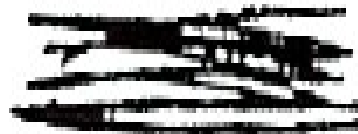

Dry Pine Needles

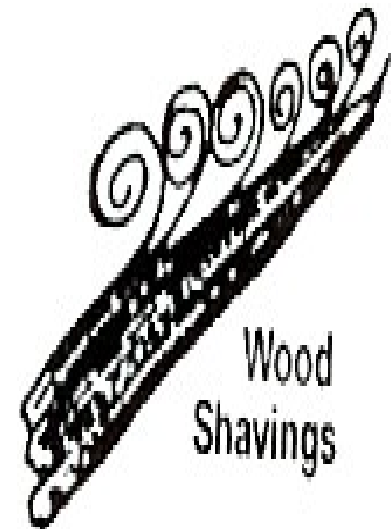

Wood
Shavings

KINDLING

(INITIAL FUEL STAGE)



Finely Split
Wood

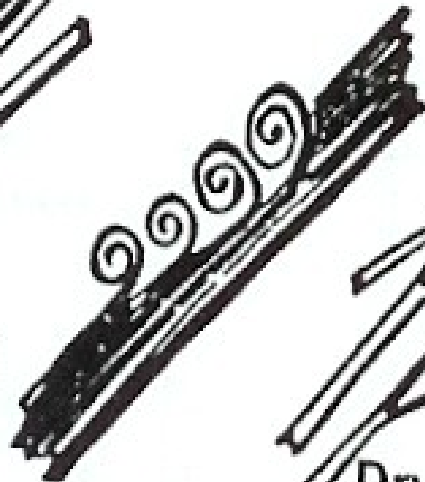

Fuzz Stick
- Carved with Knife -



Dry, Dead
Branches and
Twigs



Squaw Wood

FUEL: ANY MATERIAL
THAT WILL BURN FOR AN
EXTENDED PERIOD

- WOOD
- FISH and ANIMAL OIL
- DRIED DUNG
- BUNDLED GRASS
- COAL
- PITCH
- RESIN

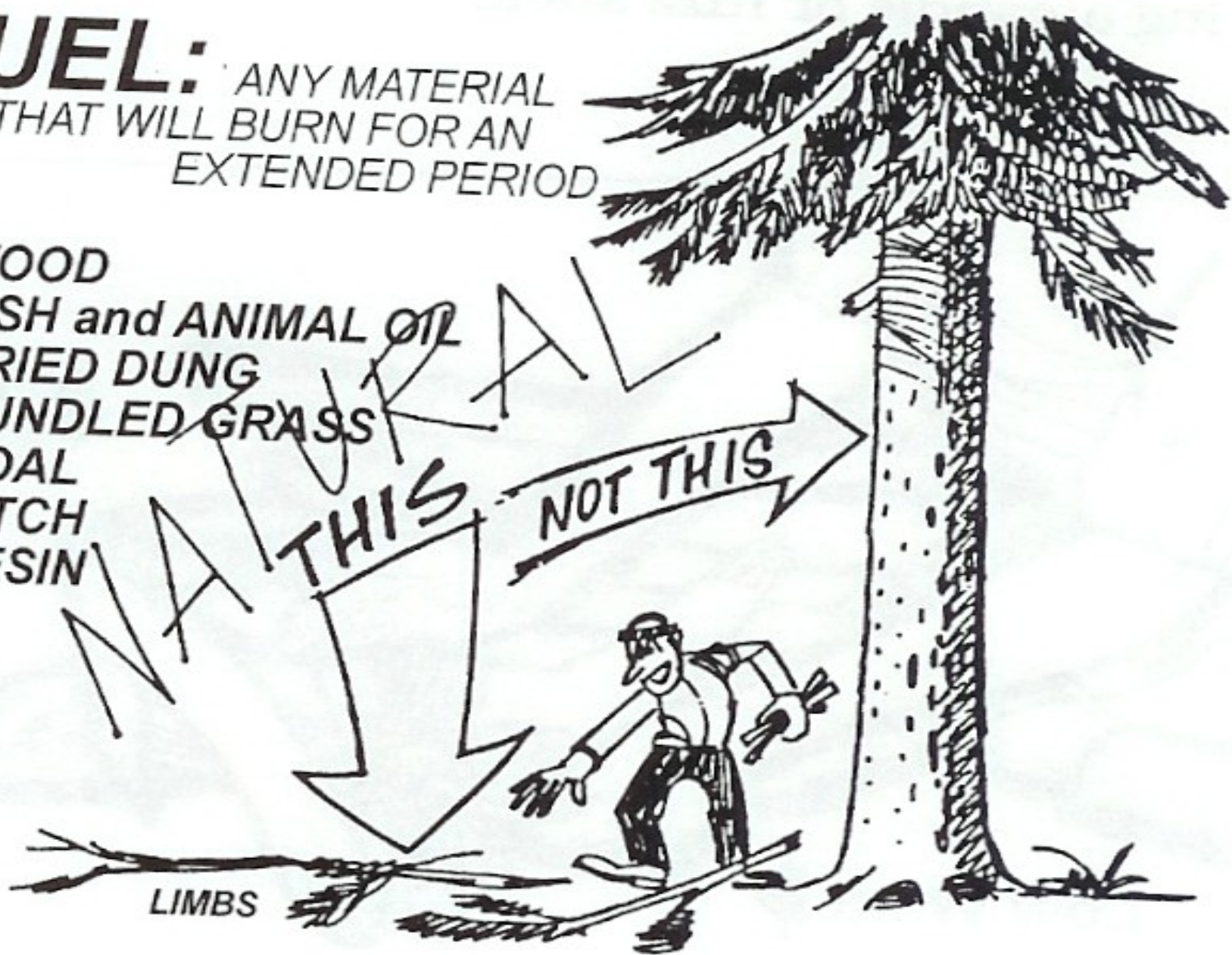



Fire Building

- Why build a fire
- General considerations
- Safety
- Materials
- Design layout

TEPEE FIRE

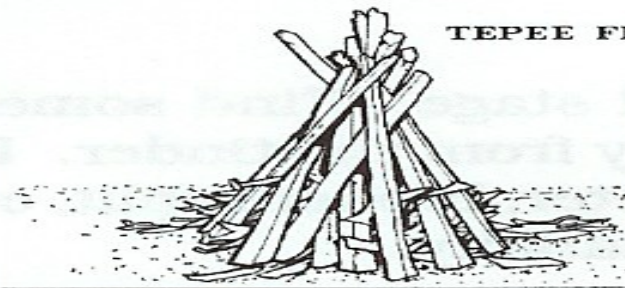

PYRAMID FIRE

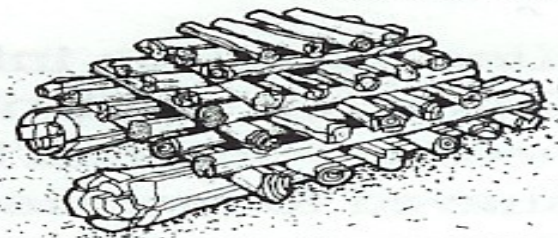

LOG CABIN FIRE

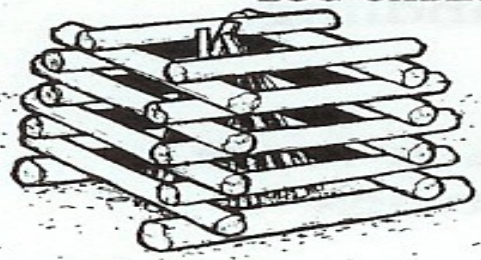

STAR FIRE

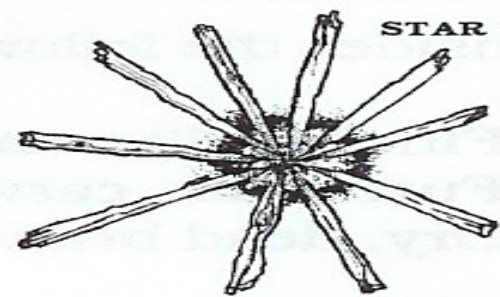

LONG FIRE

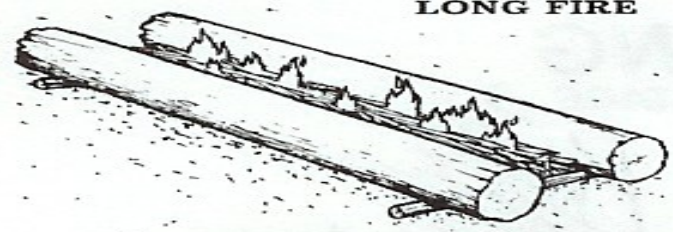

"T" FIRE



KEYHOLE FIRE

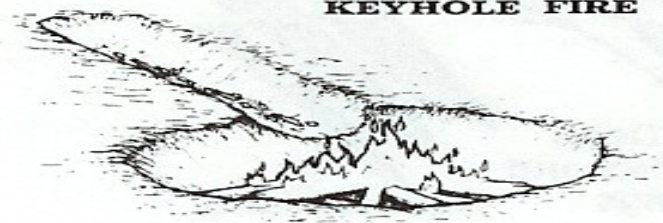

DAKOTA HOLE FIRE

